



INSTRUCTION MANUAL

Eat well, drink well and live well with Omega

www.omegajuicers.com



VRT400 SERIES

Product Contents



OMEGA PRODUCTS, INC.
6291 LYSTER LANE
HARRISBURG, PA 17111-4523 U.S.A.
PHONE: 1.800.633.3401
FAX: 717.561.1298



English, May 2013

PLEASE READ THESE INSTRUCTIONS CAREFULLY BEFORE USE

May 2013



IMPORTANT SAFEGUARDS

Please read carefully before using. Follow instructions to avoid injury.

- To protect against risk of electrical shock or fire, do not put motor base, cord, or plug in water and keep them dry at all times.
- Do not disassemble the base. All repairs should be made only by authorized personnel.
- Check voltage to be sure that the voltage indicated on the name plate agrees with your voltage.
- Close adult supervision is necessary when appliance is used by or near children.
- Unplug the power cord from the wall outlet when the appliance is not in use.
- Do not operate any appliance with a damaged cord/plug, a malfunctioning unit, or after the unit is dropped or damaged in any manner.
- The use of attachments not recommended may cause damage, fire, shock, or injury.
- Keep hands and utensils out of unit when motor is running to prevent the possibility of severe personal injury or damage to the appliance.
- Do not attempt to disassemble any attachments while the motor is running. Lift appliance with two hands (appliance weight approximately 14 lbs.)
- Do not put any parts into the dishwasher or use hard scouring powders and hard implements. Exposure to high heat can cause damage.



IMPORTANT SAFEGUARDS

Additional usage precautions:

- Do not pre-operate before inputting food. Doing so may cause a normal squeaking noise.
- Do not attempt to juice any hard materials, large seeds (seeds which can not be swallowed or chewed), pits, ice, or frozen foods.
- If food gets stuck in the feeding tube, do not use anything other than the recommended pusher.
- Do not use for more than 30 minutes continuously (only meant for household use).

SAVE THESE INSTRUCTIONS

Omega Juicer Manual For Household Use (Warranty Included)

1. Read “Precautions for safe use (Page 4)” carefully and use the appliance properly.
2. Save these instructions.
3. Check if the voltage indicated on the base of the appliance corresponds to the local voltage before you connect the appliance.

CONTENTS

Dear Omega Customers _____	1
General description and parts names _____	2
Specific terms for parts _____	3
Precautions for safe use _____	4
Warnings and cautions _____	5
Slow Juicer assembly _____	8
Slow Juicer assembly in detail _____	9
How to use the appliance _____	10
Juice Cap and Extraction Packing _____	11
When the Screw is stopped during operation _____ (How to use [Reverse/REV] button)	12
Important safeguards in use _____	13
Disassembly, cleaning and care _____	14
Bowl disassembly and wash _____	16
Sterilization and Easy Cleaning System _____	17
Spinning Brush disassembly and wash _____	18
Spinning Brush assembly _____	19
Bowl Packing assembly _____	20
Juice Cap Packing assembly _____	21
Troubleshooting _____	22
Appliance specifications _____	23

With the Omega Slow Squeezing System and Juice Cap mixing feature, you can easily make personalized juice rich in taste, flavor and full of valuable nutrients.

1. More Nutrients and Taste: Your own personalized juice

Mixed juice

Enjoy single ingredient juice or mixed juice.
Add various ingredients to your taste and health.

Alternative Meal

Make juice as an alternative meal, rich in taste and balanced nutrients.

Baby Food

Make baby food by mixing meat, grain and vegetables for various growth phases.

Soybean milk and soy juice

While the juice cap is closed, adjust the proportion of boiled beans and water to easily make soybean milk and soy juice to your desired consistency and concentration.

2. More Convenient and User Friendly

Open and close the none drip juice cap to adjust the amount of juice desired.

3. More Advanced Easy Cleaning System (Page 17)

The juice cap makes clean-up easy! Fill the bowl with water and operate the appliance for easy washing.

GENERAL DESCRIPTION AND PARTS NAMES

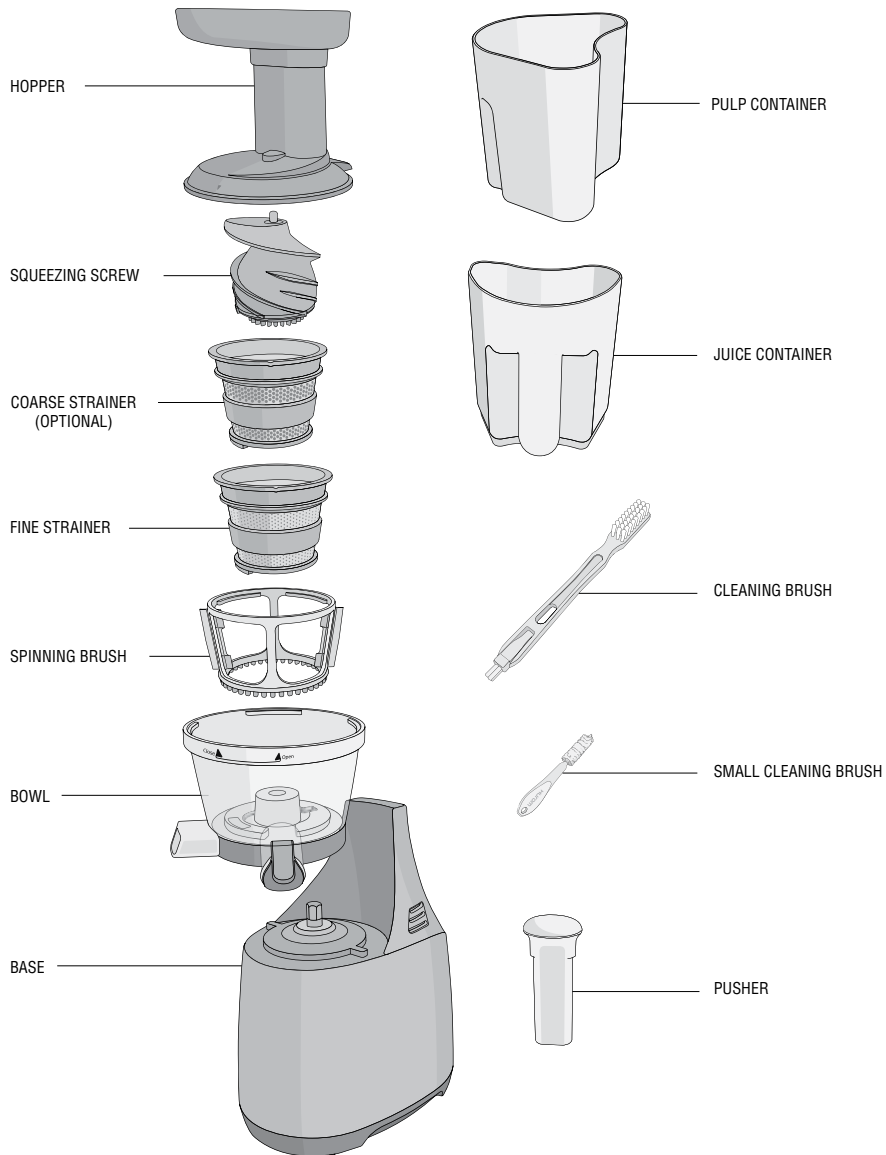

SPECIFIC TERMS FOR PARTS

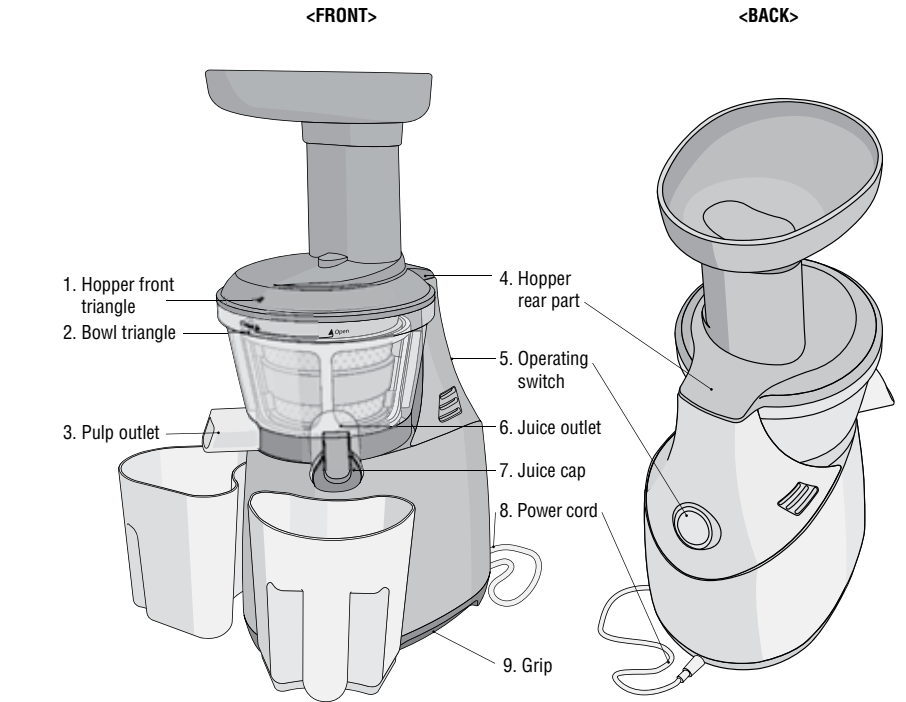

STRAINER*



COARSE STRAINER (Optional)

The bigger holes in the strainer produce thicker juice when tender and soft fruits are extracted such as strawberries, kiwis and tomatoes.

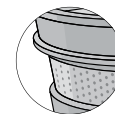

FINE STRAINER

The holes of the strainer are small. Use it when making pure juice with hard fruits, beans or higher fibered vegetables.

NUMBER OF ATTACHMENTS

1 pusher, 1 hopper, 1 screw, 1 fine strainer, 1 coarse strainer (Optional), 1 spinning brush, 1 bowl
1 base, 1 juice container, 1 pulp container, 1 small cleaning brush, 1 cleaning brush, 1 manual

PRECAUTIONS FOR SAFE USE

WARNING Hazards or unsafe practices which could result in serious personal injury or death.

CAUTION Hazards or unsafe practices which could result in minor personal injury or appliance damage.



SIGN EXAMPLES

The sign indicates contents that may cause risk of a fire or an electrical shock. Specific warnings are written in the sign.

The sign indicates contents that may cause risk of a fire or an electrical shock. Specific warnings are written in the sign.

The sign indicates prohibited acts. Specific prohibitions are written around or in the sign.

The sign indicates contents of regulating or directing actions. Specific instructions are written around or in the sign.



WARNINGS AND CAUTIONS



WARNING

Hazards or unsafe practices which could result in serious personal injury or death.



DO NOT PLUG IN OR UNPLUG WITH WET HANDS.

It may cause an electric shock or an injury.

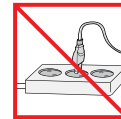

DO NOT USE WITH OTHER THAN RATED VOLTAGE.

It may cause an electric shock, a fire or abnormal performance. If the voltage is different, it may shorten the life of the motor or cause a failure.



PLUG THE POWER CORD CORRECTLY AND PUSH IT TIGHT IN A WALL SOCKET.

It may cause an electric shock or a fire.

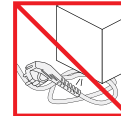

IF THE SUPPLY CORD IS DAMAGED, IT MUST BE REPLACED BY THE MANUFACTURER, ITS SERVICE OR SIMILARLY QUALIFIED PERSONS IN ORDER TO AVOID A HAZARD.

If the power cord is damaged, it may cause an electric shock or fire.



NEVER ALTER THE APPLIANCE. ALSO, DO NOT DISASSEMBLE OR REPAIR BY YOURSELF. DO NOT INSERT FINGERS, FOREIGN SUBSTANCES OR OBJECTS SUCH AS PINS INTO GAPS OR HOLES IN THE BASE.

It may cause a fire, an electric shock or a failure. For any technical support, contact the authorized local Customer Care Center.



DO NOT MOISTEN THE BASE OR SPLASH WATER ON THE BASE.

Be careful not to let any liquids or other substances get into the switch on the appliance.

DO NOT OPERATE THE SWITCH WITH WET HANDS.

It may cause an electric shock or fire.

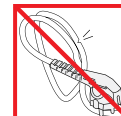

WHEN THE POWER CORD, WIRE IS BROKEN OR DAMAGED OR THE PLUG-IN PART BECOMES LOOSE, DO NOT OPERATE IT.

It may cause an electric shock, a fire or an injury.



FOR SAFETY, MUST DO GROUND CONNECTION. DO NOT DO THE GROUNDING ON GAS PIPE, PLASTIC WATER PIPE, TELEPHONE WIRE, ETC.

It could cause an electric shock, a fire, a malfunction and an explosion. Be sure to use the socket with ground connection.

WARNINGS AND CAUTIONS



NEVER DISASSEMBLE BOWL SET DURING OPERATION OR INSERT FINGERS, FOREIGN OBJECTS SUCH AS FORKS, SPOONS ETC. INTO FEEDING TUBE OR JUICE OUTLET.

It may cause an injury, an accident or a failure.



THIS APPLIANCE IS NOT INTENDED FOR USE BY PERSONS (INCLUDING CHILDREN) WITH REDUCED PHYSICAL, SENSORY OR MENTAL CAPABILITIES, OR LACK OF EXPERIENCE AND KNOWLEDGE, UNLESS THEY HAVE BEEN GIVEN SUPERVISION OR INSTRUCTION CONCERNING USE OF THE APPLIANCE BY A PERSON RESPONSIBLE FOR THEIR SAFETY.

Children should be supervised to ensure that they do not play with the appliance.



CAUTION

Hazards or unsafe practices which could result in minor personal injury or appliance damage.



DO NOT OPERATE WITHOUT LOCKING THE HOPPER PROPERLY.

It may cause an injury or a failure.

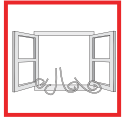

WHEN DETECTING A GAS LEAK, DO NOT INSERT THE POWER CORD INTO ITS SLOT. OPEN THE WINDOW TO VENTILATE FULLY AND IMMEDIATELY.

It may cause an injury or a failure.



NEVER PUT A FINGER, A FORK OR A SPOON ETC. INTO JUICE OUTLET.

It may cause an injury or a failure.



IF SCREW ROTATION IS STOPPED IN NORMAL OPERATION, PRESS [REVERSE/REV] BUTTON AND HOLD FOR 2~3 SECONDS AND THEN AFTER REVERSE OPERATION IS COMPLETELY STOPPED, PRESS [ON] BUTTON AGAIN.

If such a stop event continues during the operation, the parts may be damaged and performance may be deteriorated due to overheating in a motor. When the problem continues, immediately stop the appliance and contact the local Customer Care Center.



DURING THE OPERATION, DO NOT ATTEMPT TO MOVE THE BASE, DISASSEMBLE THE BOWL SET OR PARTS AND TRY TO LOCK THEM.

It may cause an injury or a failure.

Any act of event needed, switch off first and unplug the power cord.

WARNINGS AND CAUTIONS



WHEN USING THE APPLIANCE, BE CAREFUL FOR A NECKTIE, LONG NECKLACE, SCARF ETC. NOT TO BE ENTANGLED INTO FEEDING TUBE.

It may cause an injury, a failure or a breakage.



PLACE THE APPLIANCE ON A FLAT AND STABLE SURFACE.

It may cause an injury or a failure.



DO NOT OPERATE THE APPLIANCE FOR MORE THAN 30 MINUTES AT A TIME.

It may cause a motor failure due to overheating.

Cool it down sufficiently for 5 minutes and operate it again.



WHEN PLACING INGREDIENTS INTO THE FEEDING TUBE, ONLY USE THE PUSHER PROVIDED.

It may cause an injury or a failure.

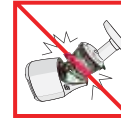

DO NOT ALLOW A SEVERE SHOCK TO THE APPLIANCE OR DROP IT.

It may cause an electric shock, a fire or damage.

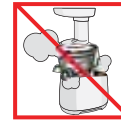

IF THE APPLIANCE GIVES OFF AN UNPLEASANT SMELL OR EXCESSIVE HEATING, SMOKE, STOP USING IMMEDIATELY AND CONTACT THE LOCAL CUSTOMER CARE CENTER.

When using a new appliance, it gives off a smell and the smell disappears naturally over time.

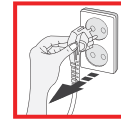

ALWAYS UNPLUG THE APPLIANCE AFTER USE. WHEN UNPLUGGING THE POWER CORD, MAKE SURE TO HOLD THE POWER CORD.

If holding the wire to unplug, it may cause an electric shock or a fire.



DO NOT WASH AT HIGH TEMPERATURES OF 800C (1760F) OR MORE. DO NOT PUT THE APPLIANCE IN A DISHWASHER, A DRYER OR A MICROWAVE ETC.

It may cause a failure or parts deformation.



THE APPLIANCE WEIGHS ABOUT 6KG (13.2LB). WHEN MOVING THE APPLIANCE, ENSURE TO MOVE IT HOLDING GRIPS TIGHTLY AT THE BASE BOTTOM WITH BOTH HANDS.

If attempting to hold bowl or the edge of the base, the base falls causing an injury or a failure.

SLOW JUICER ASSEMBLY

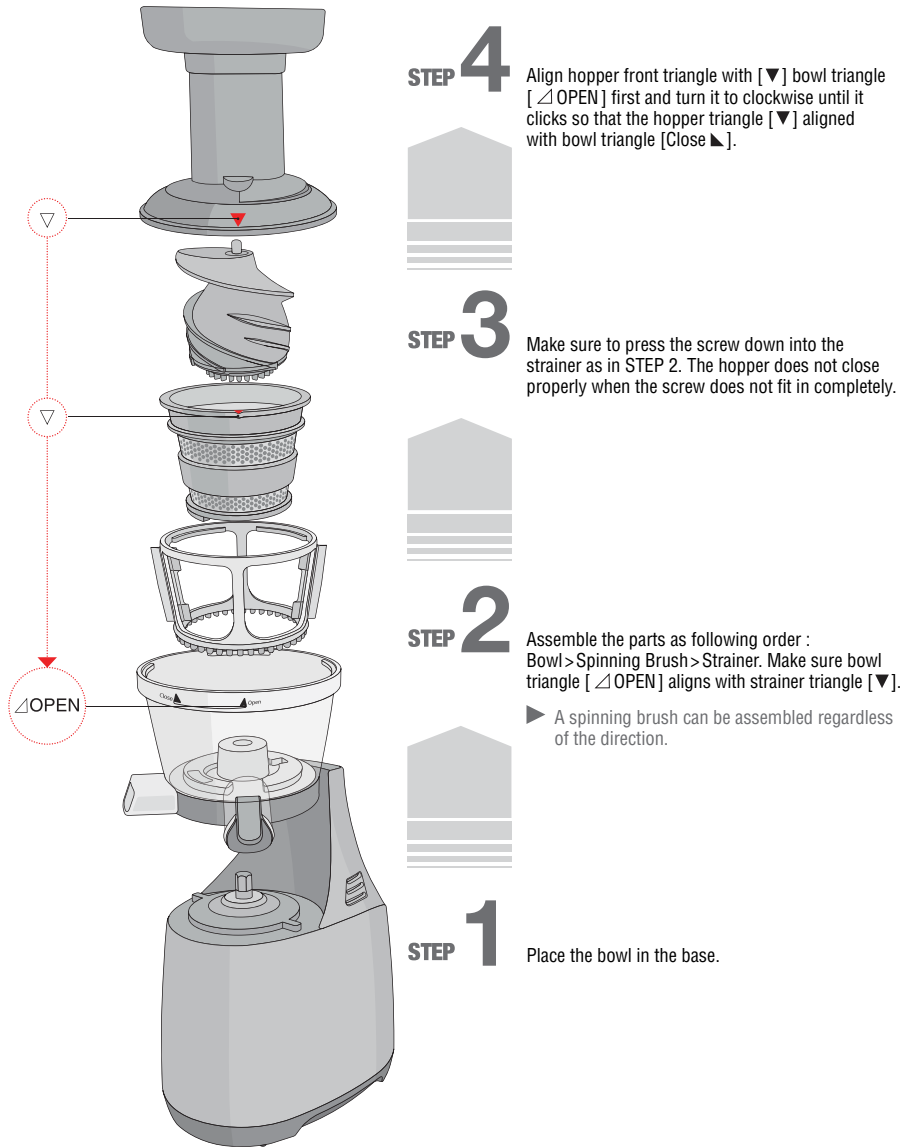

SLOW JUICER ASSEMBLY IN DETAIL

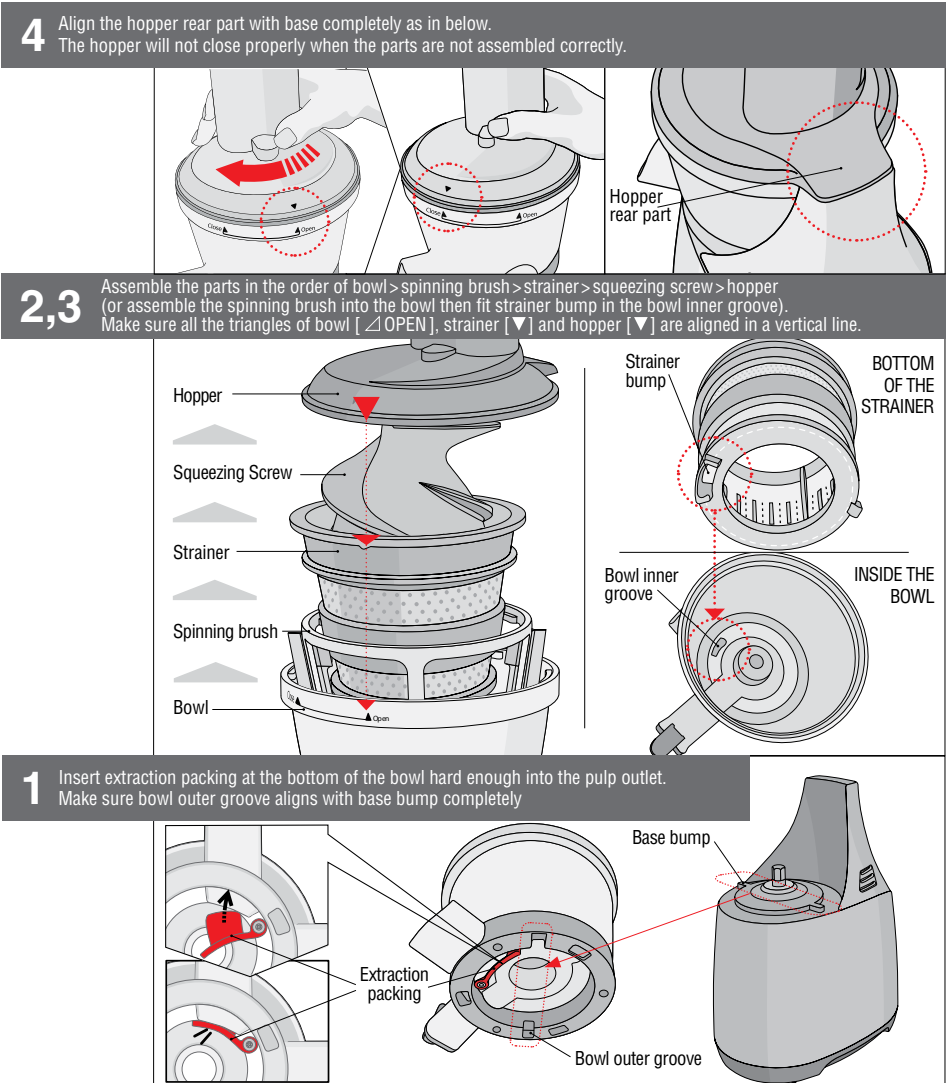

HOW TO USE THE APPLIANCE

BACK VIEW

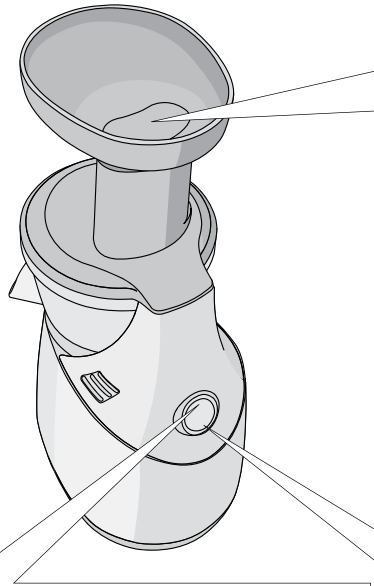

2

Wash the fruits and/or vegetables and cut them in to pieces that fit in to the feeding tube. Place the suitable pieces into feeding tube slowly and press with a pusher. Use fresh fruits and vegetables for juicing as they contain more juice.

1

OPERATING SWITCHES

Normal direction

Normal direction

Press

Reverse direction

Reverse direction

Press [On] button to start.

3

OPERATING SWITCHES

Normal direction

Normal direction

STOP status

Reverse direction

Reverse direction

After juicing is completed, click [Reverse/ REV] to stop.

► Motor does not stop immediately when clicking [Reverse/REV]. It stops slowly for safety and performance reasons.

JUICE CAP AND EXTRACTION PACKING

JUICE CAP

This is the cap of juice outlet in the bowl. Close the juice cap and fill up with juice in the bowl with various ingredients. You can easily make mixed juices.

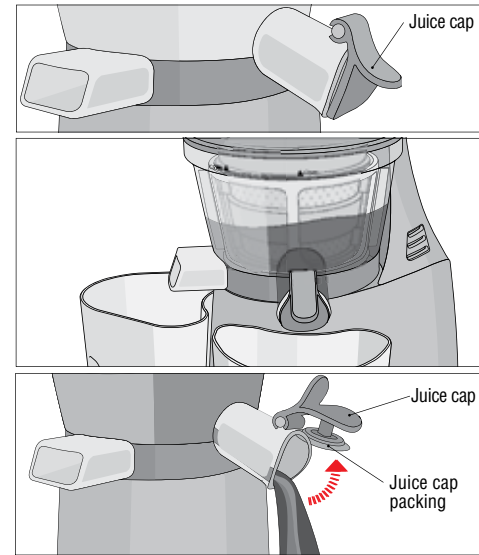

1 Close juice cap and press [ON] button to start.

2 When juice starts filling up the bowl, you can mix banana, nuts, boiled sweet potato etc. and liquids such as milk etc. as well as vegetables and fruits like smoothies.

3 Open juice cap to pour out as much juice as you want. Close juice cap without any drops.

EXTRACTION PACKING

This is the pulp stopper made of silicone at the bottom of the bowl. Make sure to close extraction packing always as shown below before use. For cleaning, let extraction packing open and start washing. (Page 16)

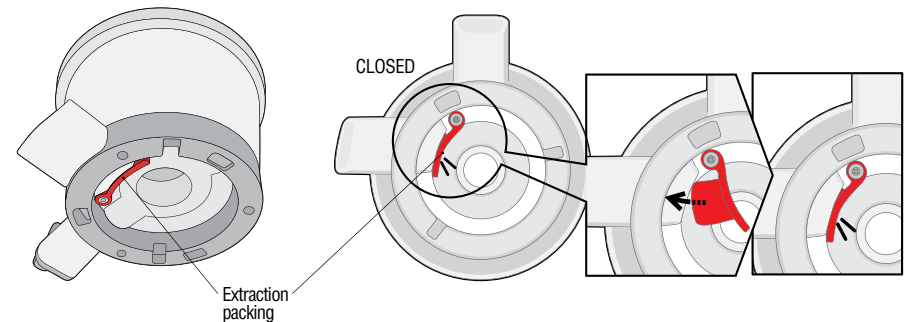

WHEN THE SCREW IS STOPPED DURING OPERATION (REVERSE/REV BUTTON)

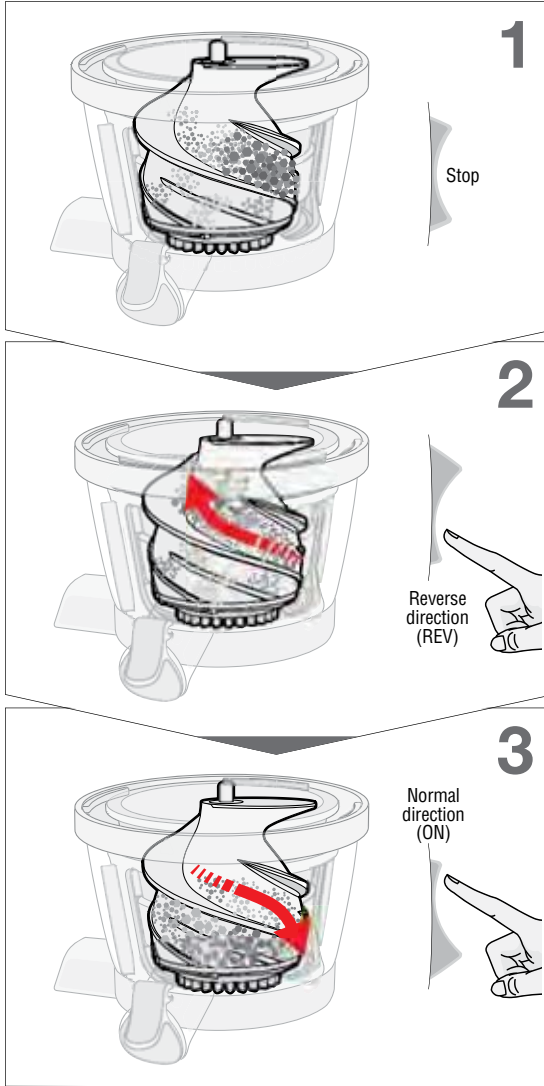

Click [Reverse/REV] button and stop the appliance.

Press [Reverse/REV] button in operating switches for 3-5 seconds and release it. Repeat this process 2-3 times.

- ▶ Reverse is the button pushing ingredients upward. Reverse only works while the button is pressed and held. Once button is released, screw rotation stops.

After the rotation stops completely, press [ON] button to operate.

- ▶ Any direction you want to change from either Normal direction or Reverse direction, make sure that screw rotation is stopped completely. Then operate any button you needs.

NOTE

If the screw does not work even after the above process, unplug the power cord from the socket, disassemble the bowl set, wash and use it again

IMPORTANT SAFEGUARDS IN USE

- Fruits with pits, hard seeds such as nectarines, peaches, mangos, apricots, plums and cherries must be pitted before juicing.
- Cut fibrous ingredients (water parsley etc.) in small size like 3~4cm (1.5inch) and place to the feeding tube
- Drink the fruit juice or green vegetable juice immediately after you have extracted. If it is exposed to air for a period of time, the juice will lose its taste and natural value.
- Do not use the appliance for grinding dry ingredients such as grains, coffee beans, etc. It may cause a part damage or a failure.
- Do not re-squeeze the pulp in the pulp outlet.
- Do not operate the appliance when the bowl is empty.



DO NOT USE IT FOR MORE THAN 30 MINUTES CONTINUOUSLY.

It may cause a failure due to overheating in a motor. When using continuously, stop and cool it down for 5 minutes in between each 30 minute use.



NEVER INSERT A FINGER, A FORK OR A SPOON, ETC. INTO JUICE OUTLET DURING OPERATION.

It may cause damage to parts.



ONLY USE THE PUSHER TO PRESS DOWN THE INGREDIENTS.

If using other object, it may cause damage to parts, an injury or a failure.



DO NOT PLACE GRAINS, FRUIT WITH HARD SEED OR NUTS WITH HARD SHELL SUCH AS WALNUTS.

It may cause damage or a failure of bowl, screw, squeezing strainer, etc. Fruits with pits, hard seeds such as nectarines, peaches, mangos, apricots, plums and cherries must be pitted before.

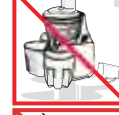

DO NOT OPERATE SWITCHES WITH WET HANDS.

It may cause an electric shock, an electric leakage or a fire. Do not leave any foreign substances around switches.



DO NOT JUICE SEAFOOD AND MEAT.

It may cause abnormal performances or a failure.



DO NOT JUICE FRUIT PRESERVED IN SUGAR, HONEY, ALCOHOL, ETC . (GRAPES, APRICOT, BERRIES, ETC.).

NOTE

Frozen fruit or withered ingredients stored in the refrigerator for a long time may produce less juice or no juice at all.

DISASSEMBLY, CLEANING AND CARE

FIGURE IN ORDER

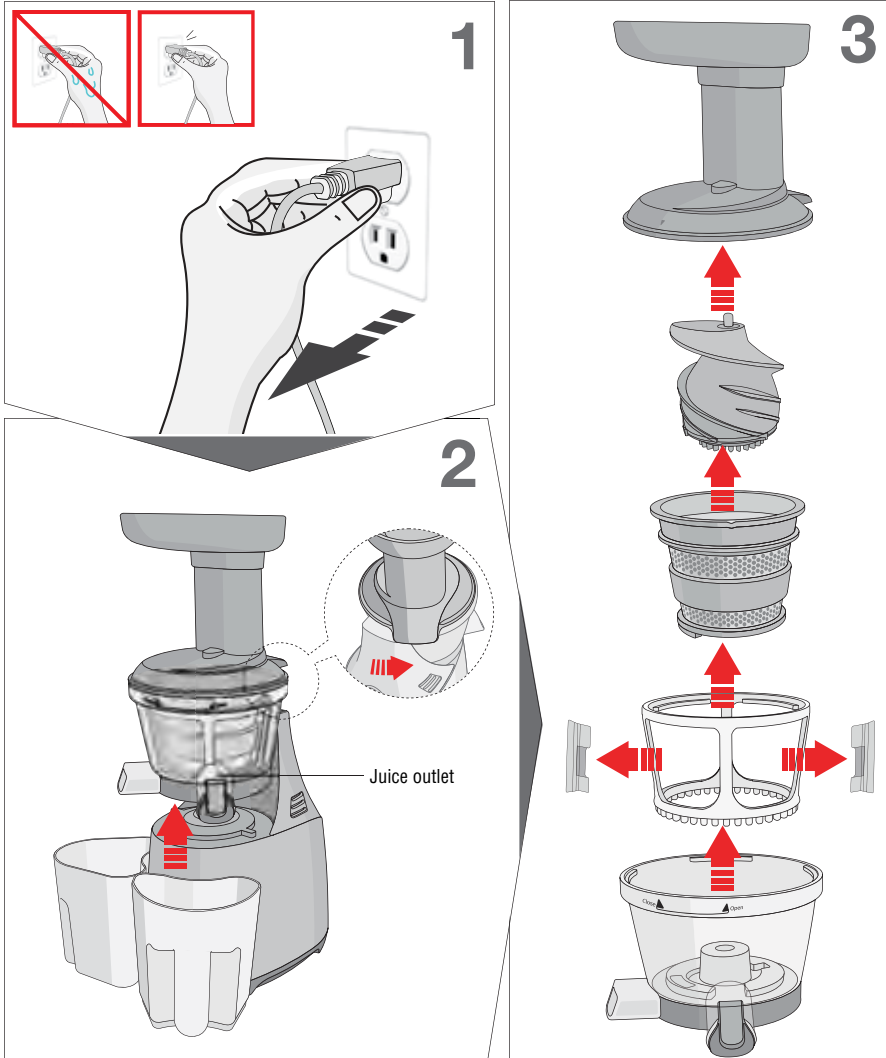

DISASSEMBLY, CLEANING AND CARE

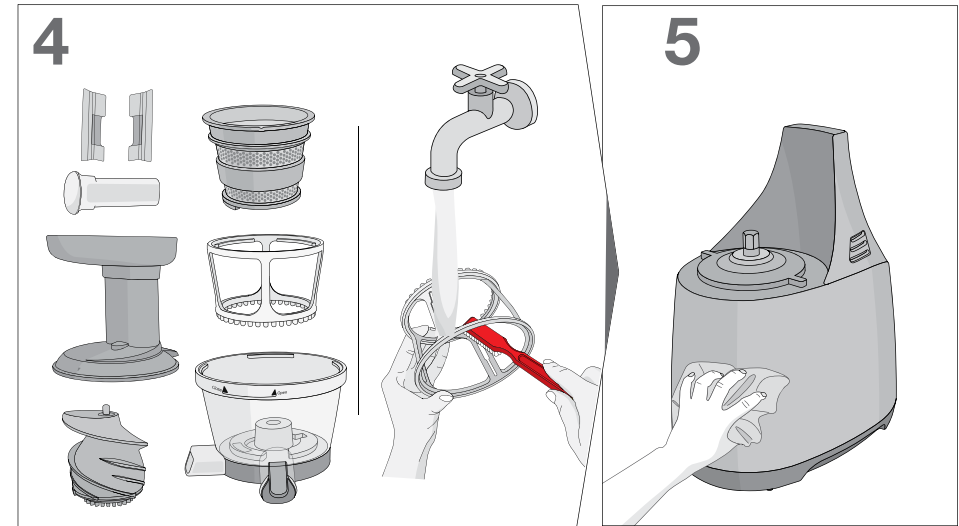

1. Ensure the motor stops completely and unplug the power cord.
 - ▶ When unplugging the power cord, hold the head part of the power cord and unplug it. Do not touch the power cord with wet hands.
2. Hold the juice outlet and the hopper with both hands and lift them up from the base.
3. Disassemble the parts as below:
 - 1) Unlock the bowl twisting to counterclockwise.
 - 2) Take the screw out.
 - 3) Remove the strainer.
 - 4) Take the spinning brush out and disassemble the silicone brush.
4. Rinse each parts with cleaning brush. Brush the inside and outside under running water.
 - ▶ Never use scouring pads, abrasive cleaning agent aggressive liquids or sharp cleaning tools. Do not wash them in a dishwasher or a dish dryer.
5. Wipe the stain on the base with soft damp cloth or wrung towel and dry the base thoroughly.
 - ▶ Do not immerse the base unit in water or any other liquid nor rinse, it under tap.
6. After each cleaning ,allow parts to air-dry completely and store in a clean and safe place.
 - ▶ Always wash the bowl set immediately after each use. If you skip this step, pulp may dry up and stick to the bowl set, making it difficult to disassemble or wash. It may also cause degradation in performance.

BOWL DISASSEMBLY AND WASH

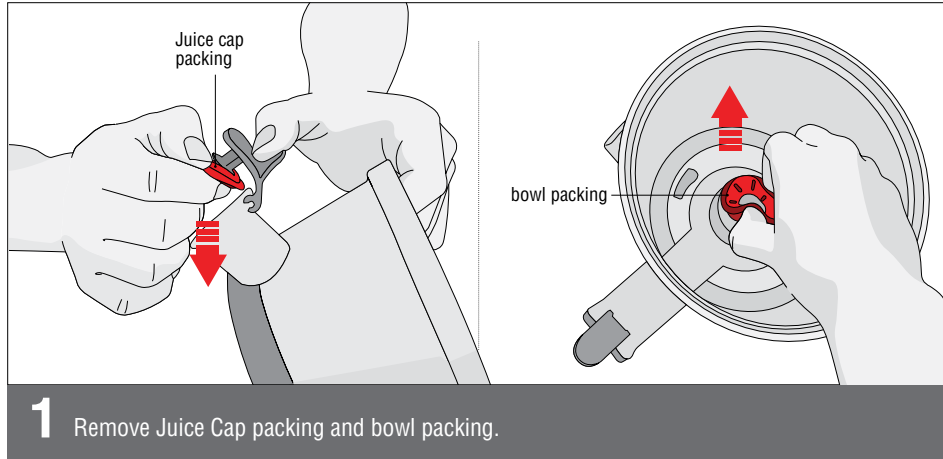

- ▶ Open juice cap first. Hold the bowl and juice cap with one hand and remove juice cap packing with the other hand. When removing it, be careful not to drop the juice cap and bowl. It may cause damage to the juice cap. Remove the bowl packing by pinching and twisting it with two fingers.

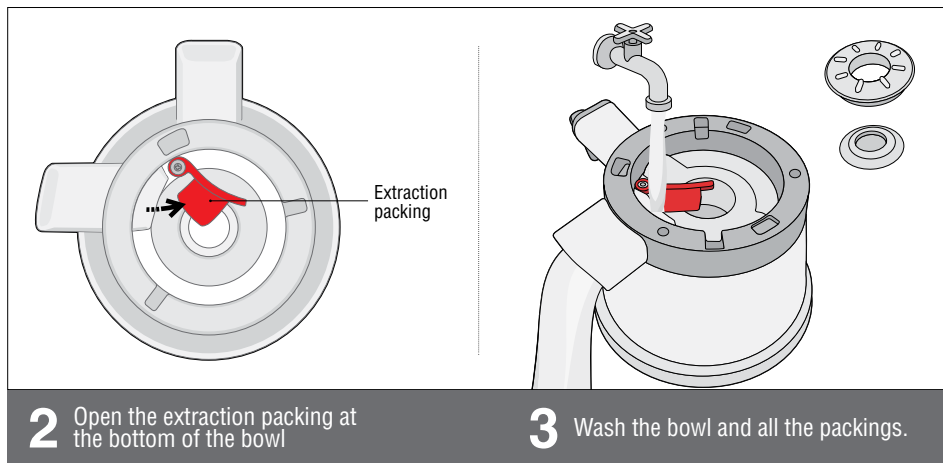

- ▶ Wash bowl and bowl packing with cleaning brush under the running water.

STERILIZATION AND EASY CLEANING SYSTEM

STERILIZATION

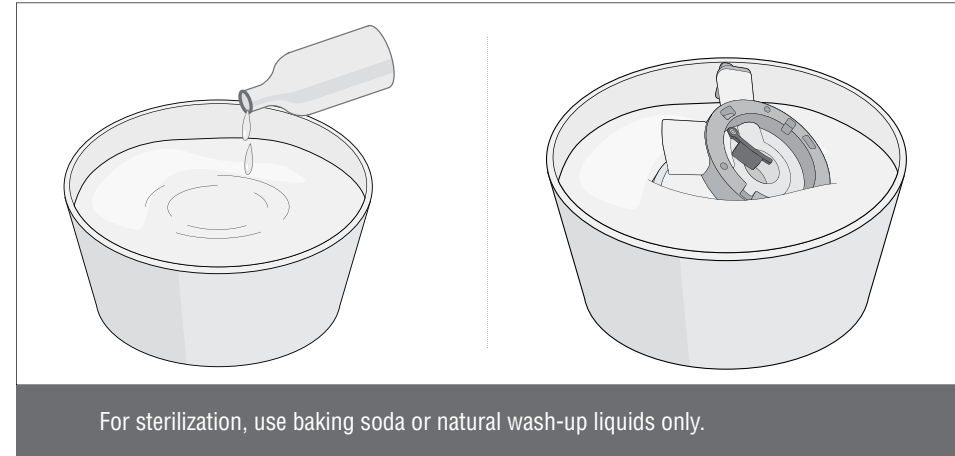

- ▶ You can thoroughly wash parts by immersing in water diluted with one or two drops of baking soda or natural wash-up liquids for about 30 minutes.

EASY CLEANING SYSTEM

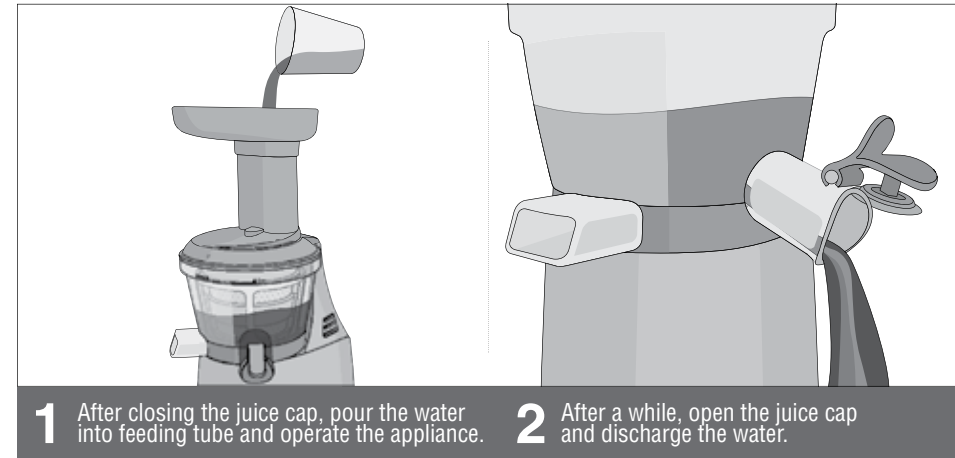

- ▶ Whenever changing the ingredient, it is not necessary to disassemble and wash the bowl. After juicing, make sure to disassemble and wash the bowl set.

SPINNING BRUSH DISASSEMBLY AND WASH

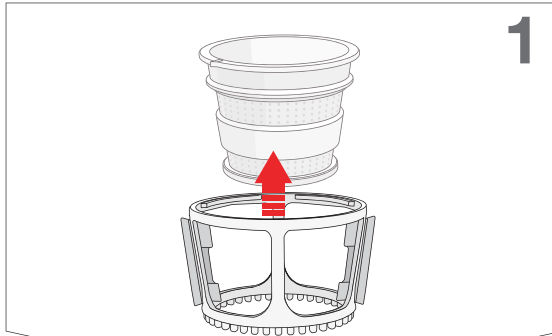

1

Remove the spinning brush from strainer.

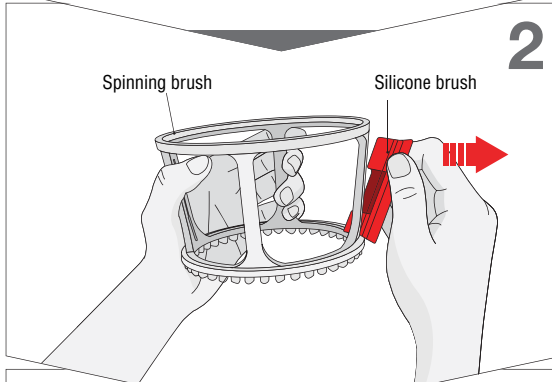

2

Detach the silicone brush from spinning brush.

- ▶ As shown to the left, hold the outer part of silicone brush with your fingers and pull it out to the arrow direction. It is recommended to remove it according to the above method. If pulling it by force, silicone brush may be torn or spinning brush may be damaged.

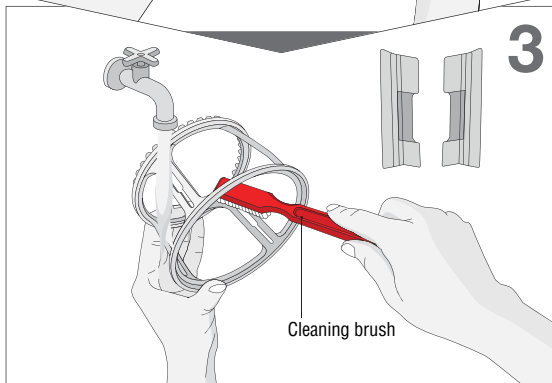

3

With cleaning brush, wash inside and outside of spinning brush like brushing under the running water.

- ▶ Wash silicone brush in the same way under the running water.

SPINNING BRUSH ASSEMBLY

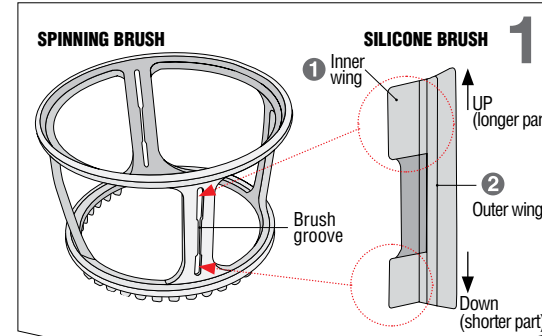

1

Check the groove of the spinning brush and the direction of silicone brush.

- ▶ There are grooves to insert silicone brush in the spinning brush. Silicone brush has inner wing **1** and outer wing **2**.
- ▶ As shown to the left, let 'inner wing' face the spinning brush.

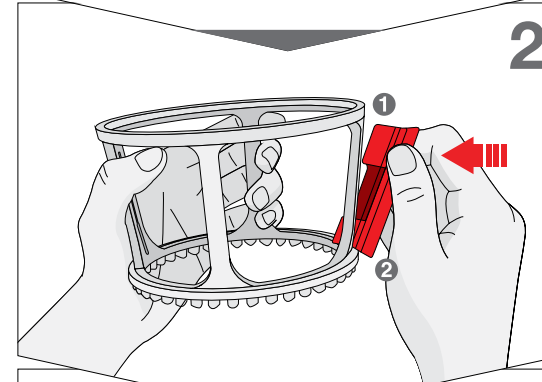

2

Insert the silicone brush into the spinning brush.

- ▶ According to the No.1 above, let the longer part of inner wing **1** face upward.
- ▶ Hold the outer wing **2** of silicone brush with your thumb and index finger and insert the inner wing into the groove of spinning brush.

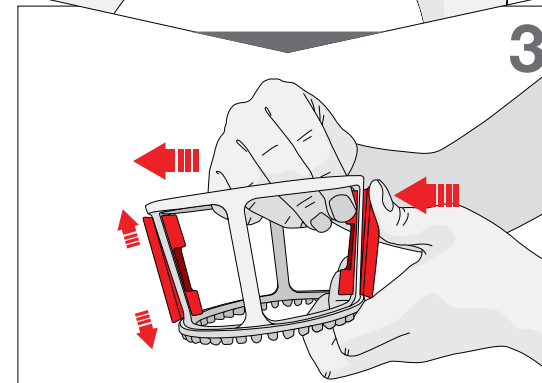

3

Pull the inner wing tight enough.

- ▶ Push silicone brush from the outer side of spinning brush and pull 'inner wing' in the direction of inside of the spinning brush with the other hand as shown to the left.
- ▶ Hold the outer wing of silicone brush. Pull it until you cannot pull it any longer. If units are operating without fully assembled, there is a risk of breakage.
- ▶ Hold up and down of 'outer wing' and pull it tight enough.

BOWL PACKING ASSEMBLY

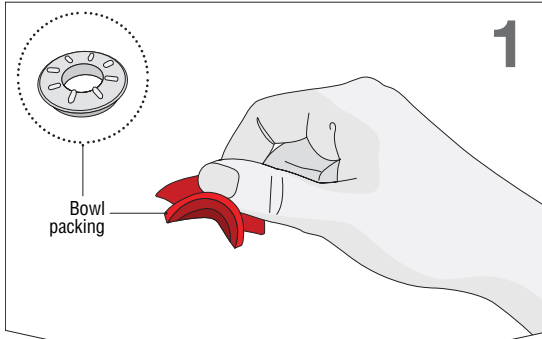

1

Hold the bowl packing like pinching.

- ▶ As shown to the left in a dotted circle, let the protrusion part on the bowl packing face upward and hold it like pinching with your thumb and index finger.

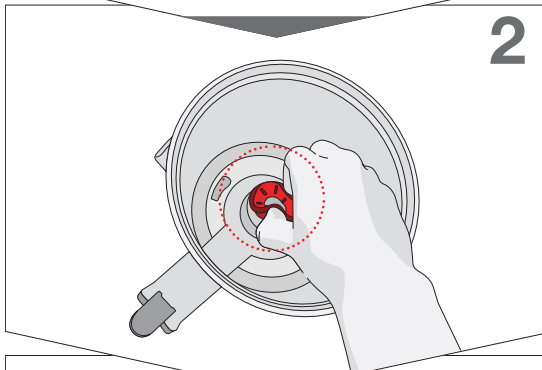

2

Insert the bowl packing into the bowl hole.

- ▶ Insert the bottom of the bowl packing into the bowl hole and fully press it down. Do not insert whole part of bowl packing. The upper part of the bowl packing must be shown.

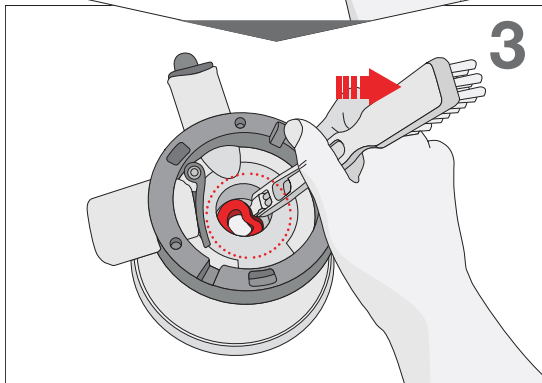

3

Turn over the bowl and organize the bowl packing in place.

- ▶ If the bowl packing at the bottom of the bowl is not fully inserted and bent, organize it with the rotating attractor of the cleaning brush.

JUICE CAP PACKING ASSEMBLY

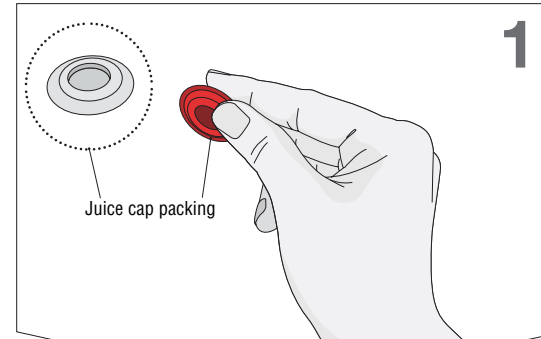

1

Hold juice cap packing as shown to the left.

- ▶ As shown to the left in a dotted circle, the hole must be visible when you hold.

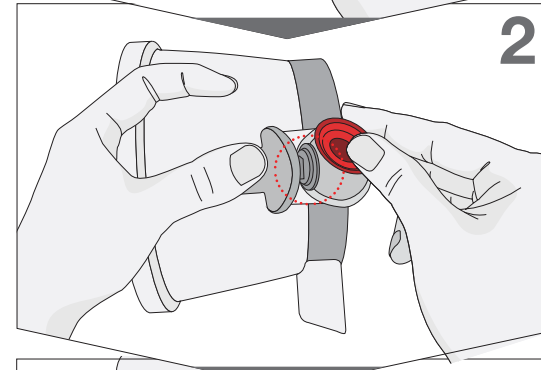

2

Open the juice cap and insert the juice cap packing in.

- ▶ Insert it in from the top to the juice cap. Be careful not to drop the bowl.

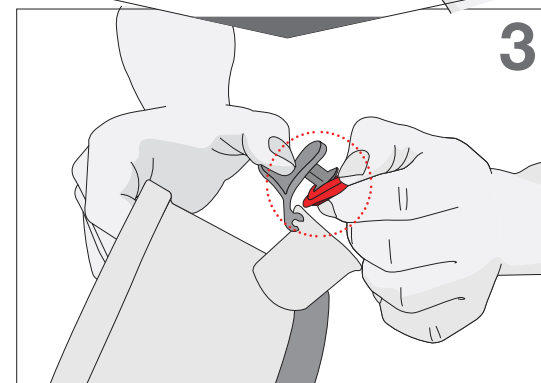

3

Organize the packing to seal off completely.

- ▶ If the packing is not completely sealed, it may cause juice leaking.

TROUBLESHOOTING

Check the details below before contacting Technical Support for repair or service.

If you need information or if you have a problem, please contact the local Customer Care Center.

When applying for after sales service, check the manufacturer's serial number or bar code.

THE APPLIANCE DOES NOT WORK.

Make sure the power cord is properly plugged in.

Check the hopper is assembled properly. If the hopper has not been properly locked in place, the appliance does not work for safety reasons.

Check if the appliance has been assembled according to the manual in an ordinary manner.

See the assembly in the manual or consult with the local Customer Care Center for help.

THE HOPPER DOES NOT OPEN.

Is there a lot of pulp left inside the bowl? Press [ON] button to discharge internal pulp.

Have you placed any foreign substances or solid objects such as hard seeds?

Press the [Reverse/REV] button to make foreign substances come up again toward the feeding tube.

Do not attempt to open it by force or with too much pressure. Still it does not work following by the above process, contact the local Customer Care Center.

IT STOPS DURING NORMAL OPERATION.

Have you put heavy loads of ingredient or a thick/big ingredient? Read the manual Page 12 and follow Reverse/REV button guideline

Still the problem has not been solved, contact the local Customer Care Center.

THERE ARE GATE MARKS (FORMING MARK) RESULTING FROM THE MOLDING PROCESS.

It is normal, and there is no problem for use.

WHAT IS THE DIFFERENCE BETWEEN FINE STRAINER AND COARSE STRAINER?

Regarding strainer selection for suitable ingredients, read the manual Page 3.

JUICE LEAKS OVER THE BASE.

Is Extraction packing properly inserted in?

Juice could leak when the extraction packing is not properly inserted. Please push the extraction packing tight enough.

Juice is still leaking even though the extraction packing was inserted properly?

If an amount of input ingredient is too much compared to the size of pulp outlet, the packing may be slightly pushed out and juice may leak through the gap. Do not process heavy loads at a time; squeeze little by little.

THE BOWL SHAKES WHEN SQUEEZING.

Slight shaking may be occurred due to motor movement.

Large or small movements occur depending on the pulp texture of ingredients (hard or tough).

It is normal when the screw is rotating. Please note that it is not malfunction.

Hard ingredients (e.g. carrots/potatoes/radishes/beetroots etc.) may shake the bowl more than soft and juicy ingredient.

APPLIANCE SPECIFICATIONS

APPLIANCE STANDARDS

PRODUCT NAME Omega Slow Squeeze Juicer

MODEL NAME VR T400 Series

RATED VOLTAGE 120 V

RATED FREQUENCY 60 Hz

RATED POWER CONSUMPTION 150 W

RPM (REVOLUTIONS PER MINUTE) 80 RPM

CORD LENGTH 1.4 m

MOTOR Single-phase induction motor

FUSE 250 V 10 A

OUT WARD DIMENSIONS Width 160 MM
Length 218 mm
Height 405 mm

RATED OPERATING TIME LESS THAN 30 MINUTES

